

PA0	40	PA0	131	PB0	
PA1	41	PA1	132	PB1	
PA2	42	PA2	133	PB2	
PA3	47	PA3	134	PB3	
PA4	SPI_NSS	50	PA4	135	PB4
PA5	SPI_SCK	51	PA5	136	PB5
PA6	SPI_MISO	52	PA6	137	PB6
PA7	SPI_MOSI	53	PA7	138	PB7
PA8	119	PA8	139	PB8	
PA9	120	PA9	140	PB9	
PA10	121	PA10	141	PB10	
PA11	122	PA11	142	PB11	
PA12	123	PA12	143	PB12	
PA13	124	PA13	144	PB13	
PA14	137	PA14/JTCK-SWCLK	145	PB14	
PA15	138	PA15/JTDI	146	PB15	
PB0	56	PB0	147	PB15	
PB1	57	PB1	148	PB15	
PB2	58	PB2-BOOT1	149	PB15	
PB3	161	PB3/JTDO	150	PB15	
PB4	162	PB4/NTRST	151	PB15	
PB5	163	PB5	152	PB15	
PB6	164	PB6	153	PB15	
PB7	165	PB7	154	PB15	
PB8	167	PB8	155	PB15	
PB9	168	PB9	156	PB15	
PB10	79	PB10	157	PB15	
PB11	80	PB11	158	PB15	
PB12	81	PB12	159	PB15	
PB13	93	PB13	160	PB15	
PB14	94	PB14	161	PB15	
PB15	95	PB15	162	PB15	
PC0	32	PC0	163	PB15	
PC1	33	PC1	164	PB15	
PC2	34	PC2	165	PB15	
PC3	35	PC3	166	PB15	
PC4	54	PC4	167	PB15	
PC5	55	PC5	168	PB15	
PC6	115	PC6	169	PB15	
PC7	116	PC7	170	PB15	
PC8	117	PC8	171	PB15	
PC9	118	PC9	172	PB15	
PC10	120	PC10	173	PB15	
PC11	120	PC11	174	PB15	
PC12	141	PC12	175	PB15	
PC13	3	PC13	176	PB15	
PC14	9	PC14	177	PB15	
PC15	10	PC15	178	PB15	
PH0	29	PH0	179	PB15	
PH1	30	PH1	180	PB15	
PH2	166	PH2	181	PB15	
PH3	31	PH3	182	PB15	
PH4	48	PH4	183	PB15	
PH5	171	PH5	184	PB15	
PDR_ON	171	PDR_ON	185	PB15	
VBAT	1	VBAT	186	PB15	
VREF+	38	VREF+	187	PB15	
VDDA	39	VDDA	188	PB15	
VDD	13	VDD	189	PB15	
VDD	23	VDD	190	PB15	
VDD	36	VDD	191	PB15	
VDD	40	VDD	192	PB15	
VDD	62	VDD	193	PB15	
VDD	70	VDD	194	PB15	
VDD	73	VDD	195	PB15	
VDD	74	VDD	196	PB15	
VDD	75	VDD	197	PB15	
VDD	91	VDD	198	PB15	
VDD	112	VDD	199	PB15	
VDD	114	VDD	200	PB15	
VDD	127	VDD	201	PB15	
VDD	136	VDD	202	PB15	
VDD	149	VDD	203	PB15	
VDD	150	VDD	204	PB15	
VDD	151	VDD	205	PB15	
VCAP-1	81	VCAP-1	206	PB15	
VCAP-2	81	VCAP-2	207	PB15	
VSSA	14	VSSA	208	PB15	
VSS	27	VSS	209	PB15	
VSS	28	VSS	210	PB15	
VSS	29	VSS	211	PB15	
VSS	30	VSS	212	PB15	
VSS	31	VSS	213	PB15	
VSS	32	VSS	214	PB15	
VSS	33	VSS	215	PB15	
VSS	34	VSS	216	PB15	
VSS	35	VSS	217	PB15	
VSS	36	VSS	218	PB15	
VSS	37	VSS	219	PB15	
VSS	38	VSS	220	PB15	
VSS	39	VSS	221	PB15	
VSS	40	VSS	222	PB15	
VSS	41	VSS	223	PB15	
VSS	42	VSS	224	PB15	
VSS	43	VSS	225	PB15	
VSS	44	VSS	226	PB15	
VSS	45	VSS	227	PB15	
VSS	46	VSS	228	PB15	
VSS	47	VSS	229	PB15	
VSS	48	VSS	230	PB15	
VSS	49	VSS	231	PB15	
VSS	50	VSS	232	PB15	
VSS	51	VSS	233	PB15	
VSS	52	VSS	234	PB15	
VSS	53	VSS	235	PB15	
VSS	54	VSS	236	PB15	
VSS	55	VSS	237	PB15	
VSS	56	VSS	238	PB15	
VSS	57	VSS	239	PB15	
VSS	58	VSS	240	PB15	
VSS	59	VSS	241	PB15	
VSS	60	VSS	242	PB15	
VSS	61	VSS	243	PB15	
VSS	62	VSS	244	PB15	
VSS	63	VSS	245	PB15	
VSS	64	VSS	246	PB15	
VSS	65	VSS	247	PB15	
VSS	66	VSS	248	PB15	
VSS	67	VSS	249	PB15	
VSS	68	VSS	250	PB15	
VSS	69	VSS	251	PB15	
VSS	70	VSS	252	PB15	
VSS	71	VSS	253	PB15	
VSS	72	VSS	254	PB15	
VSS	73	VSS	255	PB15	
VSS	74	VSS	256	PB15	
VSS	75	VSS	257	PB15	
VSS	76	VSS	258	PB15	
VSS	77	VSS	259	PB15	
VSS	78	VSS	260	PB15	
VSS	79	VSS	261	PB15	
VSS	80	VSS	262	PB15	
VSS	81	VSS	263	PB15	
VSS	82	VSS	264	PB15	
VSS	83	VSS	265	PB15	
VSS	84	VSS	266	PB15	
VSS	85	VSS	267	PB15	
VSS	86	VSS	268	PB15	
VSS	87	VSS	269	PB15	
VSS	88	VSS	270	PB15	
VSS	89	VSS	271	PB15	
VSS	90	VSS	272	PB15	
VSS	91	VSS	273	PB15	
VSS	92	VSS	274	PB15	
VSS	93	VSS	275	PB15	
VSS	94	VSS	276	PB15	
VSS	95	VSS	277	PB15	
VSS	96	VSS	278	PB15	
VSS	97	VSS	279	PB15	
VSS	98	VSS	280	PB15	
VSS	99	VSS	281	PB15	
VSS	100	VSS	282	PB15	
VSS	101	VSS	283	PB15	
VSS	102	VSS	284	PB15	
VSS	103	VSS	285	PB15	
VSS	104	VSS	286	PB15	
VSS	105	VSS	287	PB15	
VSS	106	VSS	288	PB15	
VSS	107	VSS	289	PB15	
VSS	108	VSS	290	PB15	

APM32F407G

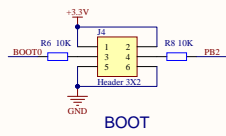

BOOT

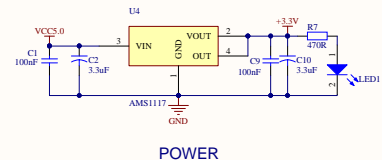

POWER

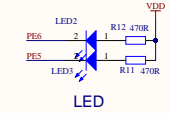

LED

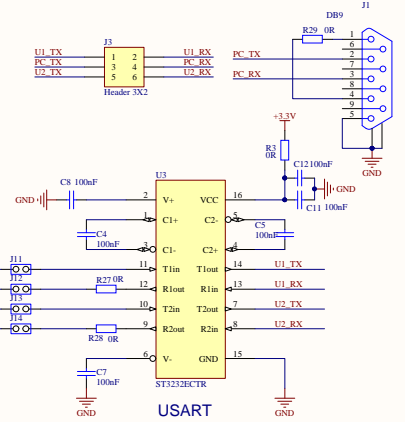

USART

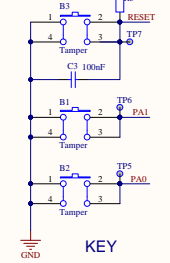

KEY

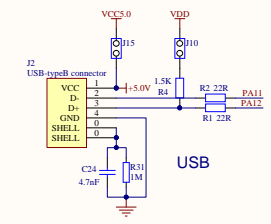

USB

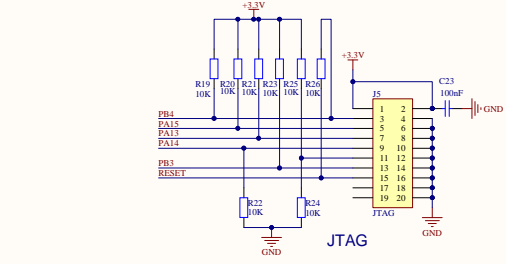

JTAG

